

???????????

CHIAO WEI MACHINERY INDUSTRIES CO.,LTD.

??? MIXER

?

1

???
JOB.NO.

???
FILE

? ?
DESIGN

? ?
DRAW

JANE

? ?
APPR.

? ?
CHECK

? ?
REVISE

? ?
DATE

2004/07/01

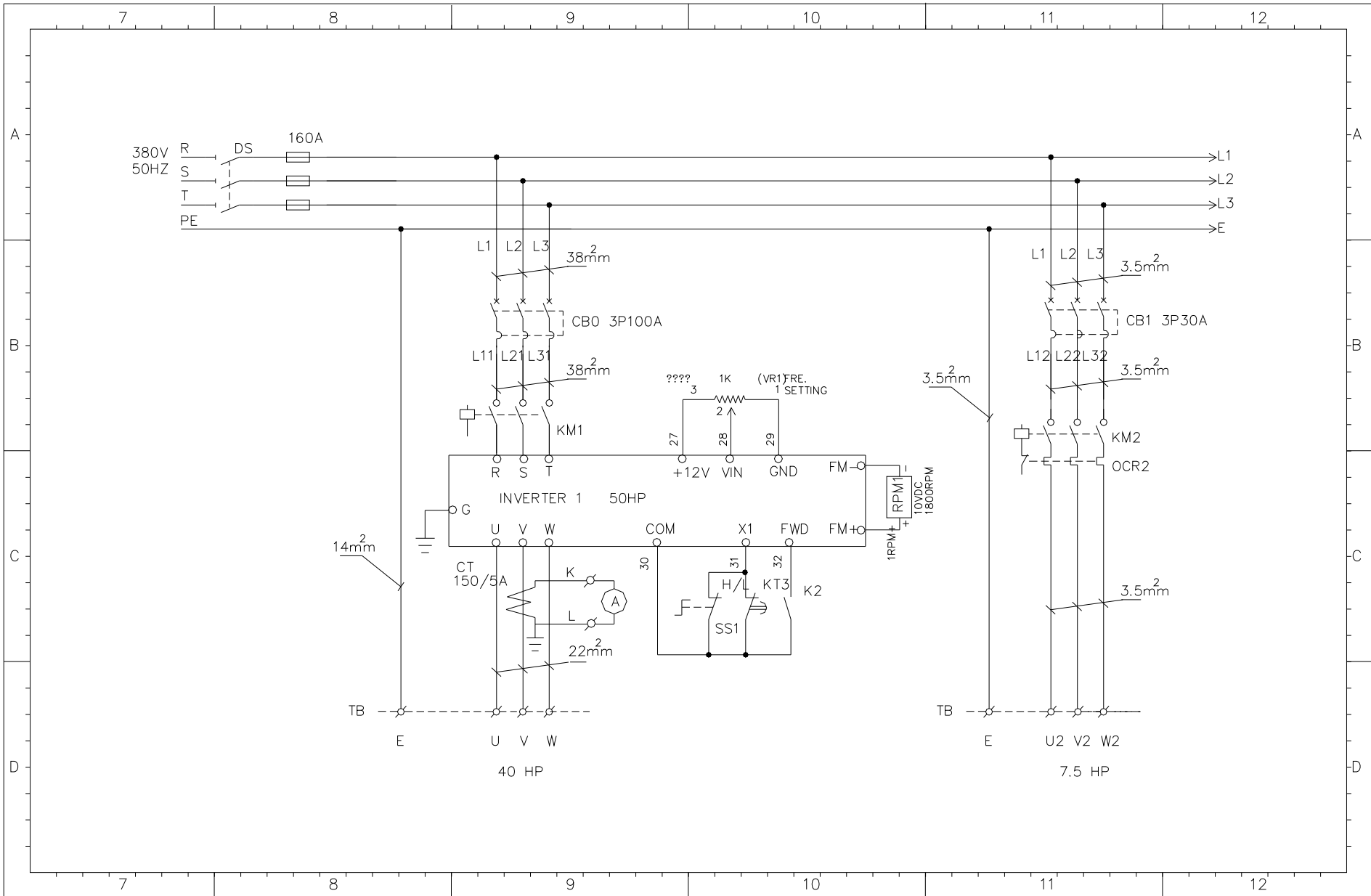

??????????
CHIAO WEI MACHINERY INDUSTRIES CO.,LTD.

??? MIXER

?
?
2

????
JOB.NO.
????
FILE

? ?
DESIGN
? ?
DRAW

JANE

? ?
APPR.
? ?
CHECK

? ?
REVISE
? ?
DATE

2004/07/01

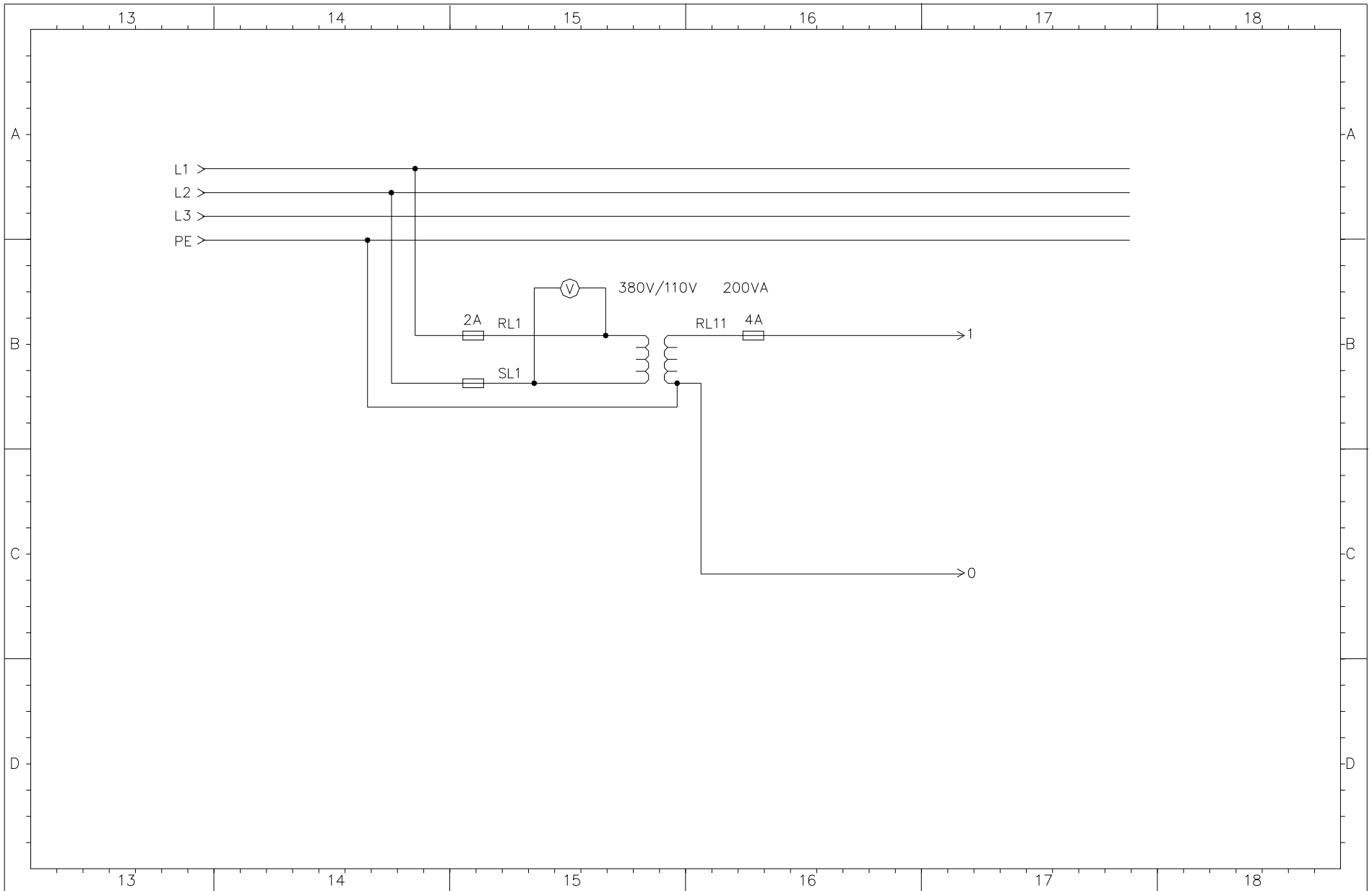

??????????
 CHIAO WEI MACHINERY INDUSTRIES CO.,LTD.

??? MIXER

?	3	???? JOB.NO.	? ? DESIGN	? ? APPR.	? ? REVISE
?		???? FILE	? ? DRAW	? ? CHECK	? ? DATE
			JANE		2004/07/01

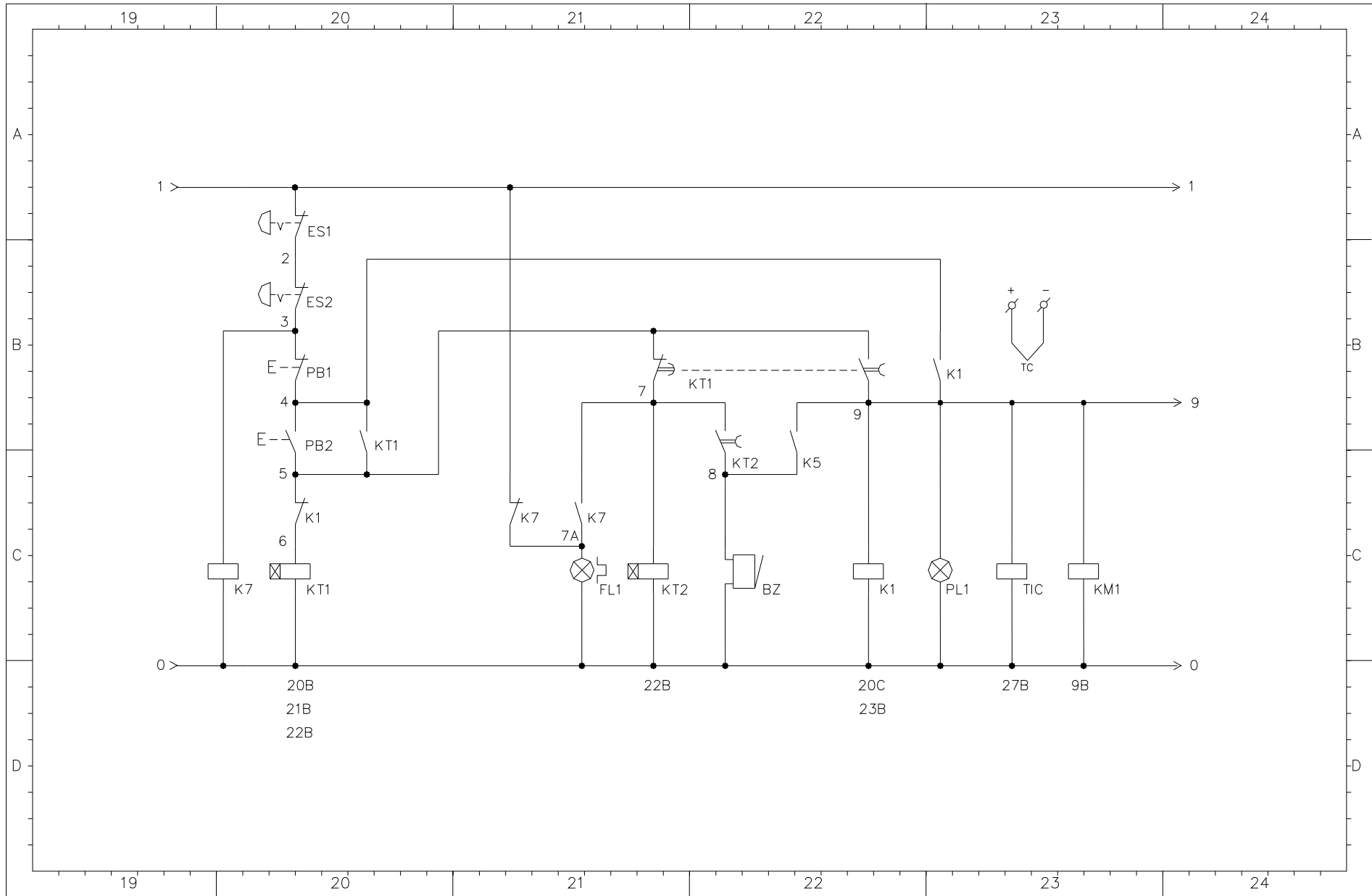

19	20	21	22	23	24			
 ?????????? CHIAO WEI MACHINERY INDUSTRIES CO.,LTD.		??? MIXER	? 4 ?	???? JOB.NO. ???? FILE	? ? DESIGN ? ? DRAW JANE	? ? APPR. ? ? CHECK	? ? REVISE ? ? DATE	2004/07/01

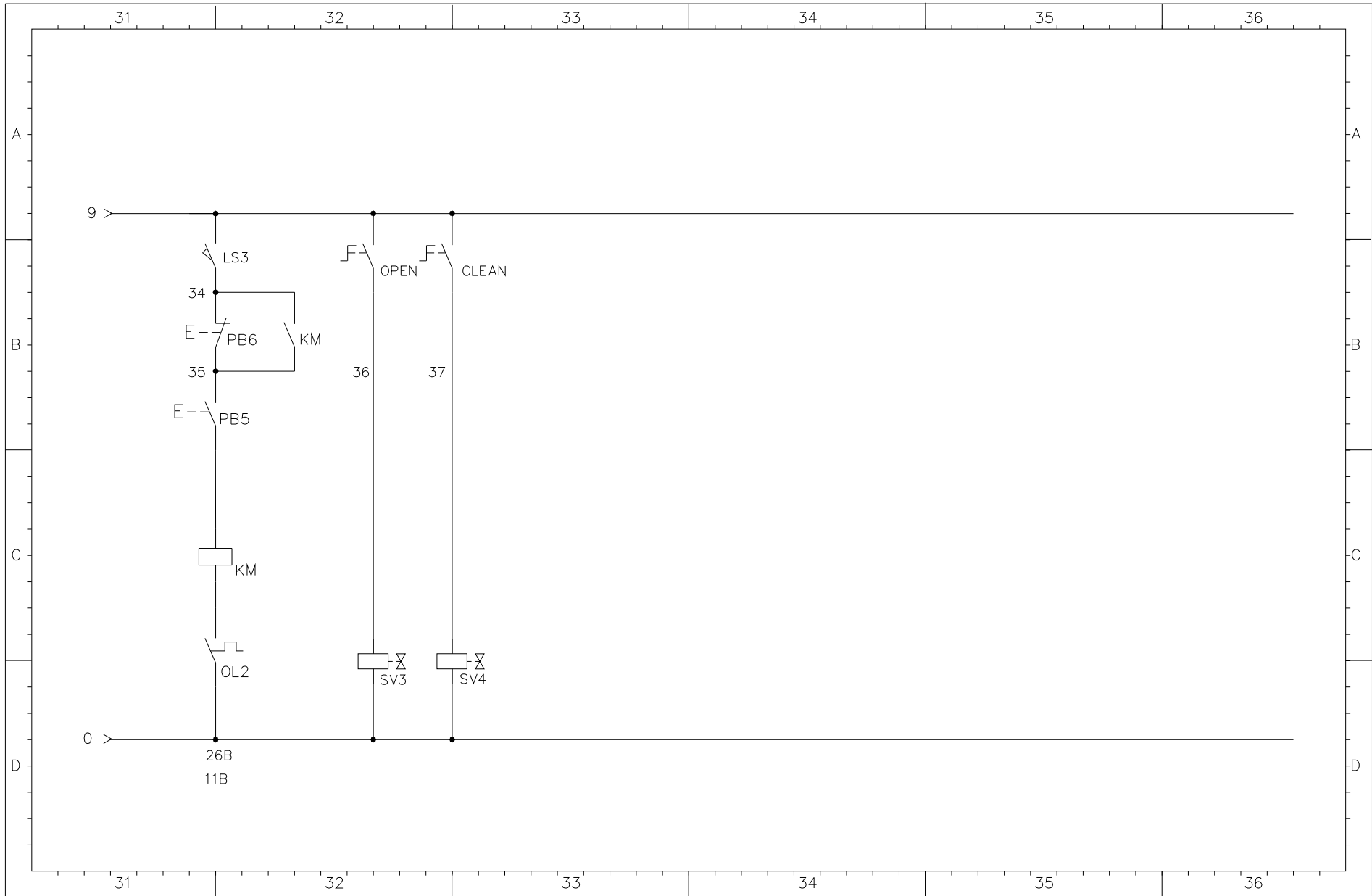

??????????
CHIAO WEI MACHINERY INDUSTRIES CO., LTD.

??? MIXER

?	6	???? JOB NO.	?	?	DESIGN	?	?	APPR.	?	?	REVISE		
?		???? FILE	?	?	DRAW	JANE	?	?	CHECK	?	?	DATE	2004/07/01

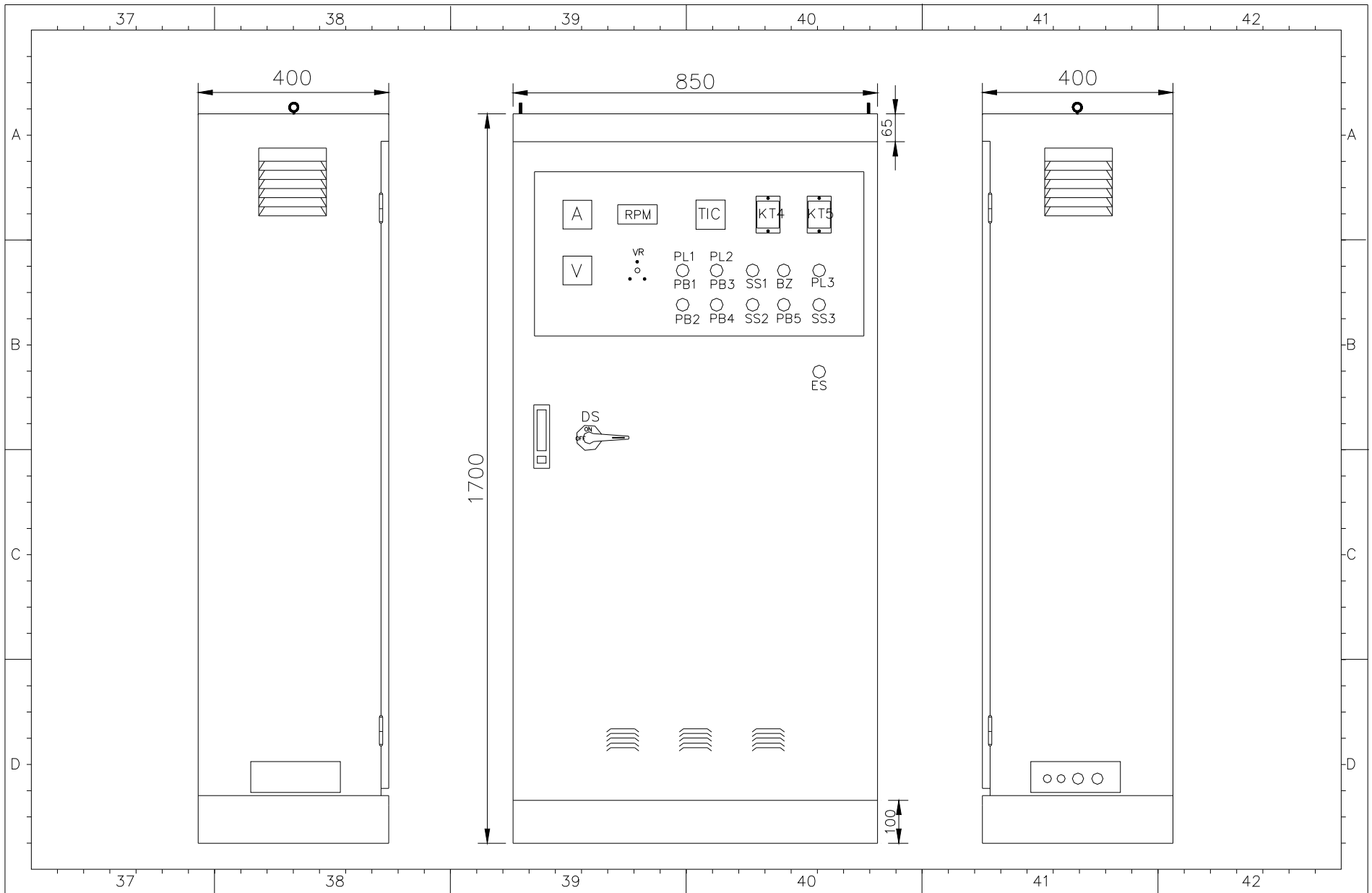

??????????
CHIAO WEI MACHINERY INDUSTRIES CO., LTD.

??? MIXER

?
?
7

????
JOB NO.
????
FILE

? ?
DESIGN
? ?
DRAW



















JANE

? ?
APPR.
? ?
CHECK

? ?
REVISE
? ?
DATE

2004/07/01

43	44	45	46	47	48				
A	?????					A			
	NO.	? ?	? ?	? ?	? ? ?				
	1	V	VOLTAGE METER	0~600V 72*72	1				
	2	A	CURRENT METER	150/5A 72*72	1				
	3	RPM	SPEED METER	0~1800rpm 10VDC	1				
B	4	TIC	MIXING TEMPEATURE	??MC-2738-101-000 (TAIE FY-700-101-000)	1				
	5	KT4	MIXING TIME	STON ASY-3DY 110V	1				
	6	KT5	DRAW OFF TIME	STON ASY-3DY 110V	1				
	7	PB1(PL1)	POWER ON	AP NFLPB-30W 1a	1				
	8	PB2	POWER OFF	AP APB-30B 1b	1				
C	9	PB3(PL2)	MAIN DRIVE ON	AP NFLPB-30G 1a	1				
	10	PB4	MAIN DRIVE OFF	AP APB-30B 1b	1				
	11	SS1	LOW SPEED/HIGHT SPEED	TSS-30B 1a1b	1				
	12	SS2	MANU./AUTO.	TEND TSS-30B 1a1b	1				
	13	BZ	BUZZER	TEND TBY-302 8VA 110V	1				
D	14	PB5	BUZZER STOP	AP APB-30B 1a	1				
	15	PL3	DRAW LAMP	TEND TPRF-30Y	1				
	43	44	45	46	47	48			
 ??????????? CHIAO WEI MACHINERY INDUSTRIES CO.,LTD.		??? MIXER		? 8	? ? JOB.NO. ? ? ? ? FILE	? ? DESIGN ? ? ? DRAW JANE	? ? APPR. ? ? CHECK	? ? REVISE ? ? DATE	2004/07/01

	49	50	51	52	53	54																																																												
A	<table border="1"> <thead> <tr> <th>NO.</th> <th>? ?</th> <th>? ?</th> <th>? ?</th> <th>? ?</th> <th>? ? ?</th> </tr> </thead> <tbody> <tr> <td>16</td> <td>SS3</td> <td>DRAW OFF</td> <td>TEND TSS-30G 1a</td> <td>1</td> <td></td> </tr> <tr> <td>17</td> <td>ES</td> <td>EMERGENCY STOP</td> <td>AP ALEPB-30R 1b</td> <td>1</td> <td></td> </tr> <tr> <td>18</td> <td>DS</td> <td></td> <td>TG550410</td> <td>1</td> <td></td> </tr> <tr> <td>19</td> <td></td> <td></td> <td>FU-9703C 158*158</td> <td>2</td> <td></td> </tr> <tr> <td>20</td> <td></td> <td>FAN</td> <td>110V</td> <td>2</td> <td></td> </tr> <tr> <td>21</td> <td>SS4</td> <td>COOLLER DOOR OPEN</td> <td>TEND TSS-30G 1a</td> <td>1</td> <td></td> </tr> <tr> <td>22</td> <td>SS5</td> <td>COOLLER DOOR CLEAN</td> <td>TEND TSS-30G 1a</td> <td>1</td> <td></td> </tr> <tr> <td>23</td> <td>PB5(PL4)</td> <td>COOLLER START</td> <td>AP NFLPB-30G 1a</td> <td>1</td> <td></td> </tr> <tr> <td>24</td> <td>PB6</td> <td>COOLLER STOP</td> <td>AP APB-30B 1b</td> <td>1</td> <td></td> </tr> </tbody> </table>						NO.	? ?	? ?	? ?	? ?	? ? ?	16	SS3	DRAW OFF	TEND TSS-30G 1a	1		17	ES	EMERGENCY STOP	AP ALEPB-30R 1b	1		18	DS		TG550410	1		19			FU-9703C 158*158	2		20		FAN	110V	2		21	SS4	COOLLER DOOR OPEN	TEND TSS-30G 1a	1		22	SS5	COOLLER DOOR CLEAN	TEND TSS-30G 1a	1		23	PB5(PL4)	COOLLER START	AP NFLPB-30G 1a	1		24	PB6	COOLLER STOP	AP APB-30B 1b	1	
NO.	? ?	? ?	? ?	? ?	? ? ?																																																													
16	SS3	DRAW OFF	TEND TSS-30G 1a	1																																																														
17	ES	EMERGENCY STOP	AP ALEPB-30R 1b	1																																																														
18	DS		TG550410	1																																																														
19			FU-9703C 158*158	2																																																														
20		FAN	110V	2																																																														
21	SS4	COOLLER DOOR OPEN	TEND TSS-30G 1a	1																																																														
22	SS5	COOLLER DOOR CLEAN	TEND TSS-30G 1a	1																																																														
23	PB5(PL4)	COOLLER START	AP NFLPB-30G 1a	1																																																														
24	PB6	COOLLER STOP	AP APB-30B 1b	1																																																														
B																																																																		
C																																																																		
D	<table border="1"> <tr> <td>PL4</td> <td></td> </tr> <tr> <td></td> <td></td> </tr> <tr> <td>PB5</td> <td>SS5</td> </tr> <tr> <td></td> <td></td> </tr> <tr> <td>PB6</td> <td>SS4</td> </tr> </table>						PL4				PB5	SS5			PB6	SS4																																																		
PL4																																																																		
																																																																		
PB5	SS5																																																																	
																																																																		
PB6	SS4																																																																	
	49	50	51	52	53	54																																																												



??????????
CHIAO WEI MACHINERY INDUSTRIES CO.,LTD.

??? MIXER

?	9	???? JOB.NO.	?? ? DESIGN	?? ? APPR.	?? ? REVISE
?		???? FILE	?? ? DRAW	JANE	?? ? CHECK
					?? ? DATE

2004/07/01

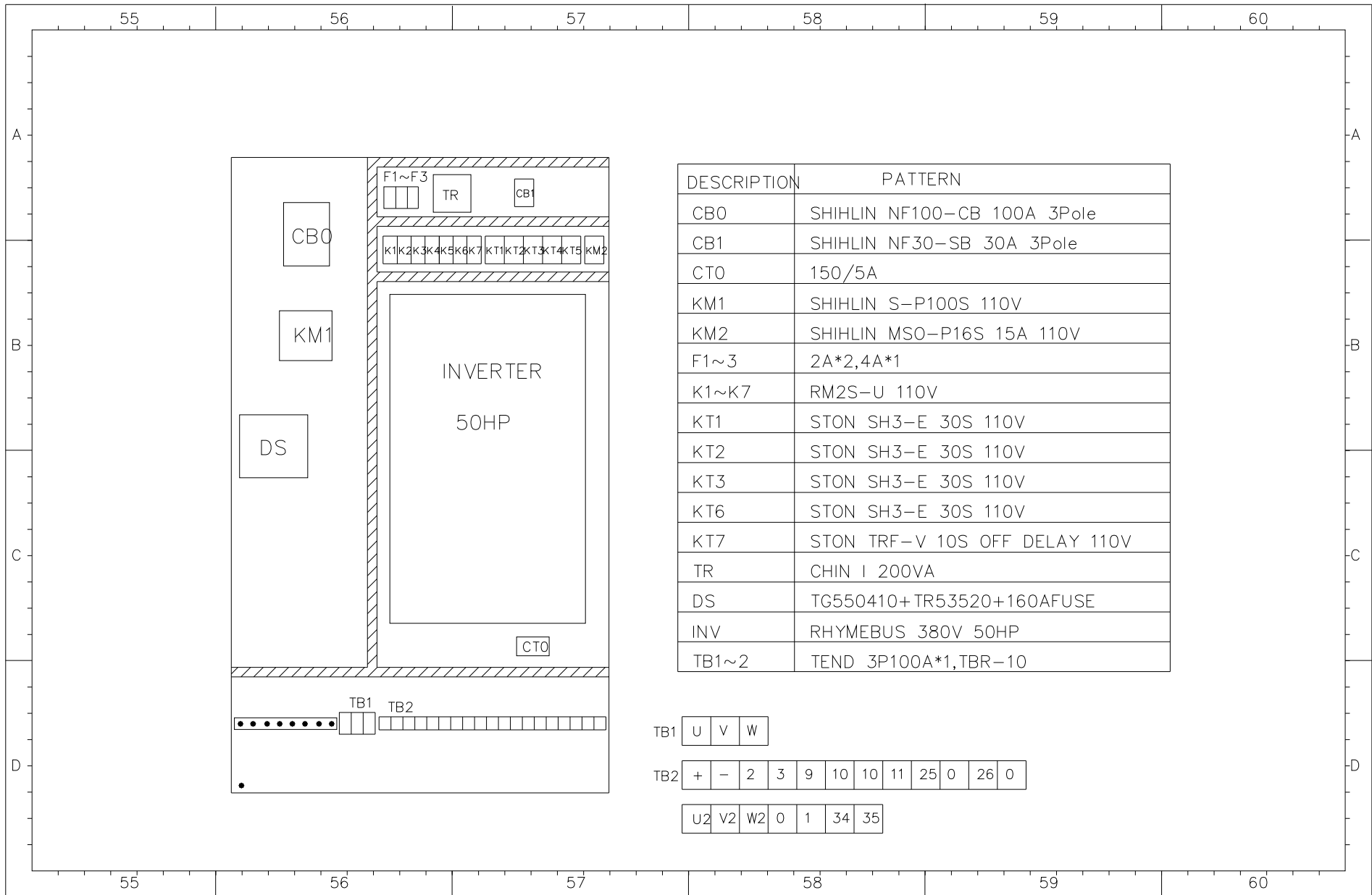

DESCRIPTION	PATTERN
CB0	SHIHLIN NF100-CB 100A 3Pole
CB1	SHIHLIN NF30-SB 30A 3Pole
CT0	150/5A
KM1	SHIHLIN S-P100S 110V
KM2	SHIHLIN MS0-P16S 15A 110V
F1~3	2A*2,4A*1
K1~K7	RM2S-U 110V
KT1	STON SH3-E 30S 110V
KT2	STON SH3-E 30S 110V
KT3	STON SH3-E 30S 110V
KT6	STON SH3-E 30S 110V
KT7	STON TRF-V 10S OFF DELAY 110V
TR	CHIN I 200VA
DS	TG550410+TR53520+160AFUSE
INV	RHYMEBUS 380V 50HP
TB1~2	TEND 3P100A*1,TBR-10

TB1 U V W

TB2 + - 2 3 9 10 10 11 25 0 26 0

U2 V2 W2 0 1 34 35